

SPICE thermal model

BUK9Y07-30B

Symbol	Parameter	Conditions	Min	Typ	Max	Unit
$R_{th(j-mb)}$	thermal resistance from junction to mounting base		-	-	1.42	K/W

C_{th1}	4.181E-02 F
C_{th2}	6.609E-03 F
C_{th3}	1.555E-03 F
C_{th4}	3.660E-04 F
C_{th5}	8.612E-05 F
C_{th6}	2.026E-05 F
C_{th7}	4.768E-06 F
C_{th8}	1.122E-06 F
R_{th1}	9.566E-01 Ω
R_{th2}	3.520E-01 Ω
R_{th3}	8.699E-02 Ω
R_{th4}	2.150E-02 Ω
R_{th5}	5.313E-03 Ω
R_{th6}	1.313E-03 Ω
R_{th7}	3.245E-04 Ω
R_{th8}	8.021E-05 Ω

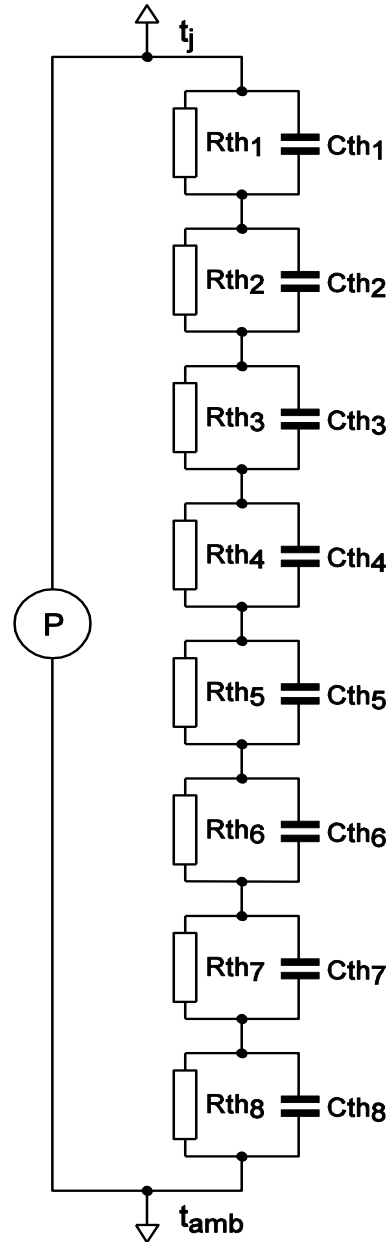

001aal768

Part: BUK9Y07-30B
 Version: 1
 Date: 23-3-2010
 Rth: 1.42